

MANISCOPIC

MHT 10160 L

Turbo

- Capacity : 16000 kg
- Lift height : 9.70 m
- Maximum forward reach : 5.50 m
- Engine : 175 HP
- 4 wheel steer – 4 wheel drive
- Hydrostatic transmission
- Frame levelling 10°/10°



 **MANITOU**

MHT 10160 L TURBO

LOAD CENTRE AT 600 MM

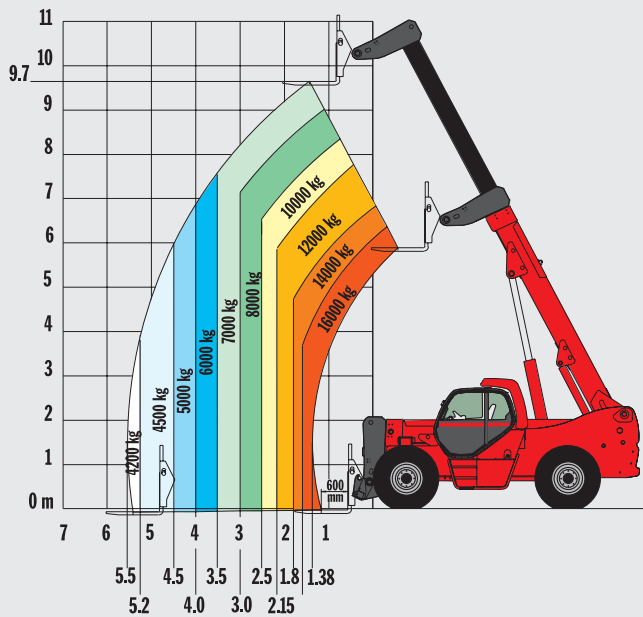

LOAD CENTRE AT 1200 MM

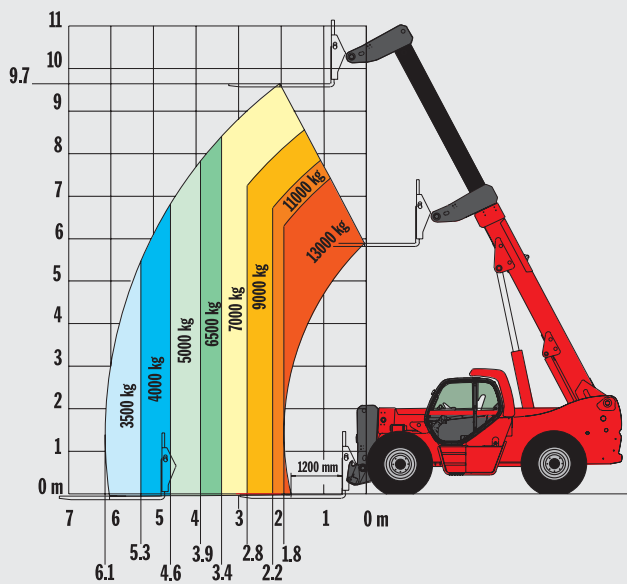

ENGINE

Diesel MERCEDES OM 904 LA Turbo – Intercooler – Air / Air

Capacity : 4 cylinders / 4250 cm3
 Power (ISO/TR 14396) : 175 HP / 129 kw
 Rated speed : 2200 r.p.m.
 Maximum torque at 1200 r.p.m. : 675 Nm

Electronic injection (4 injection pumps and 4 injectors)

Fan : puller
 Cooling : water

Anti-polluting standards
 Air filter (type / micron) : cartridge / 3
 Battery : 12 Volts
 Capacity : 120 Ah

LIFT CAPACITY / HEIGHT

Load centre	at 600 mm	at 1200 mm
Lift capacity :	16000 kg	13000 kg
Capacity at max. height :	7000 kg	7000 kg
Capacity at max. front reach :	4200 kg	3500 kg
Lift height :	9.70 m	9.70 m
Maximum front reach :	5.50 m	6.10 m

TRANSMISSION

Hydrostatic transmission **REXROTH**

Hydrostatic variable flow pump : 125 cm3
 Hydrostatic variable cylinder engine : 160 cm3
 Reversing shift : electro-magnetic
 Differential central : YES

2 forward and reverse speeds :

Low speed : 10 km/h
 Fast speed : 25 km/h

HYDRAULICS

Main pump : Piston Load Sensing REXROTH Haute pression

Capacity : 75 cm3
 Maximum pressure : 350 bar
 Flow : 170 L/mn
 Max. flow on attachment (at 280 bar) : 120 L/mn

Steering pump :

Type : Load sensing
 Maximum pressure : 210 bar

Power brake circuit pump :

Type : **REXROTH**
 Capacity : 25.7 cm3
 Maximum pressure : 40 bar
 Flow : 59 L/mn

Hydraulic oil radiator :

2 continuous fans
 2 automatic fans

Distributor : Big flow hydraulic proportional REXROTH (280 to 300 L/mn) with 4 closed centre elements

Drive Type :

Electro-Proportional hydraulic joystick with 3 movement combination

- 1- Lifting / Crowding
- 2- Boom extension / Attachment
- 3- Lifting / Boom extension

Flexibles :

TP tube type with high pressure type flexible links

Filtration degree (micron) :

Suction : 250 mic
 Return : 10 mic
 Filtration air tank : 10 mic

DIAGRAMS

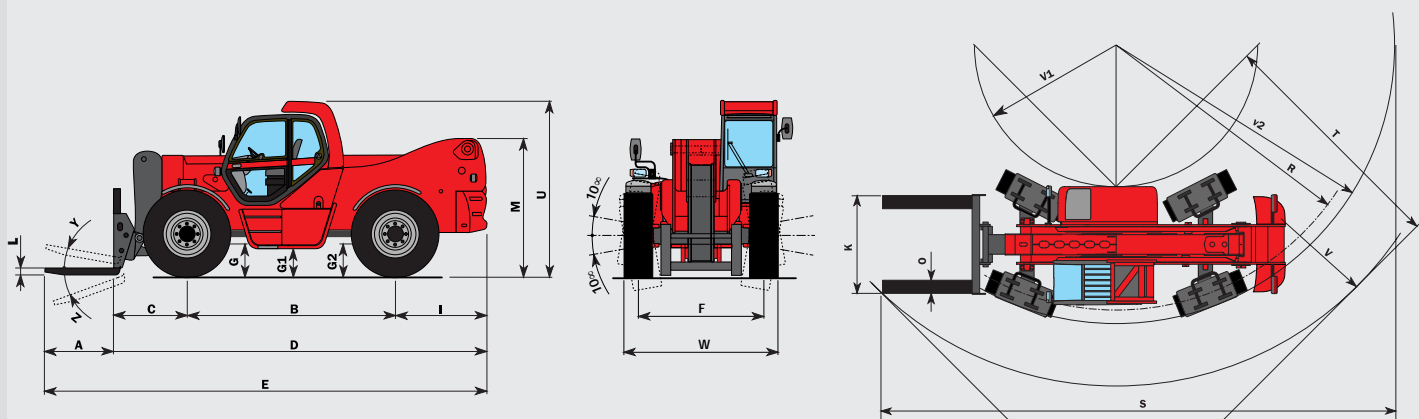

A	B	C	D	E	F	G	G1	G2	I	K	L	M	O	R	S	T	U	V	V1	V2	W	Y	Z
1500	3650	1335	6605	8105	2000	685	445	685	1620	1750	80	2300	200	5445	10345	4255	2935	6810	2870	5685	2500	12°	105°

AXLES

OMCI (stacker) Heavy Duty type, oil bath with epicycloidal reduction with 3 satellites Integrated steering cylinders with double action in high position

Frame levelling 10°/10° on front axle

3 steering modes:

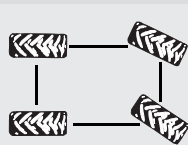

2 WHEEL STEERING

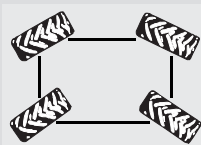

4 WHEEL STEERING

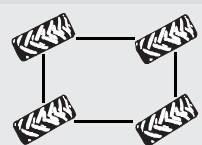

CRABSTEER

BRAKES

Type : oil bath multidisc
 Drive type : hydraulic
 On axle : front + rear

Parking brake on front and rear axles :
 Oil bath multidisc negative parking brake

TYRES

Model : 16.00 R 25
 Pressure : 9 bar
 Drawbar pull : 15500 daN

LIFTING/TELESCOPING MOTIONS

Unladen lifting : 25 sec
 Unladen lowering : 17 sec

Unladen extending internal telescope : 14 sec
 Unladen retracting internal telescope : 11 sec

FORKS

Standard equipment TFF MT 1750
 Dimensions : 200 x 80 x 1500 mm
 Weight of forks : 560 kg

CAPACITIES

Cooling circuit : 16 L
 Engine oil : 15.8 L
 Equipment hydraulic oil : 290 L
 Fuel tank : 200 L

WEIGHT

Total weight without equipment : 22300 kg
 Total weight unladen with forks : 23615 kg
 Total weight laden with forks : 39615 kg

Load on axle with standard equipment (unladen)

On front axle, boom retracted : 9430 kg
 On rear axle, boom retracted : 14185 kg

Load on axle with standard equipment (laden)

On front axle, boom retracted : 34200 kg
 On rear axle, boom retracted : 5415 kg

STANDARD EQUIPMENTS

- ROPS-FOPS cabin
- GRAMMER seat
- Front and rear wipers
- Driving lights
- Rotating beacon
- Left rearview mirror
- Safety device with automatic lock of aggravating movements
- Safety valves on cylinders
- Heating
- TFF

OPTIONS

- Air conditioning
- Comfort seat
- Roof wipers
- Cabin rearview mirror

Equipment customised on order



Manitou, material handling world leader

Inventor of the rough terrain forklift truck, Manitou offers today the most comprehensive range to meet all specific handling and personal lifting requirements :

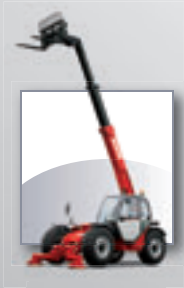

MANISCOPIC
Telescopic trucks



MANITOU
Rough terrain and semi industrial masted trucks



MANIACCESS
Access equipment



Twisco
Compact telescopic handler



MANIHOE
Backhoe/Loader with telescopic boom



MANITRANSIT
Truck mounted forklifts



MANILOADER
Articulated wheeled loaders



MANILEC
Electric pallet trucks and electric stackers

A network of skilled professionals at your service !

With a network of 600 service and parts centres in more than 120 countries, Manitou provides an efficient after-sales support based on the expertise of thousands of factory trained technicians.



The equipment supplied with each model may differ from that described in this leaflet. For more details, contact your MANITOU dealer.